

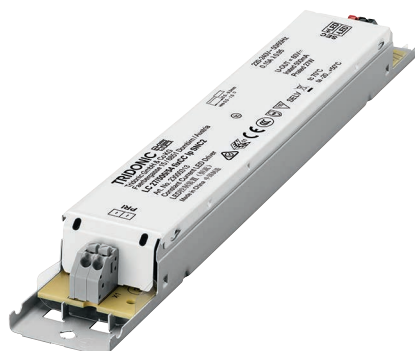

Driver LC 27W 500mA fixCC Ip SNC2 China Domestic essence series

Product description

- Fixed output built-in LED Driver
- Constant current LED Driver
- Output current 500 mA
- Max. output power 27 W
- Up to 89 % efficiency
- For luminaires of protection class I and protection class II
- Temperature protection as per EN 61347-2-13 C5e
- Nominal life-time up to 50,000 h
- 3-year guarantee (conditions at www.tridonic.com)



Housing properties

- Casing: metal, white
- Type of protection IP20



Functions

- Overload protection
- Short-circuit protection
- No-load protection

Typical applications

- For linear/area lighting in office applications



Standards, page 3

Wiring diagrams and installation examples, page 4

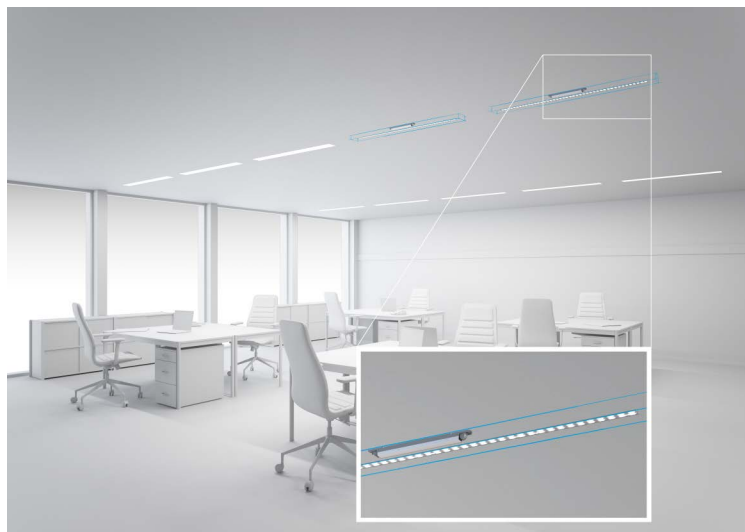

IP20 SELV 

Driver LC 27W 500mA fixCC Ip SNC2 China Domestic

essence series

Technical data

Rated supply voltage	220 – 240 V
AC voltage range	198 – 264 V
Input current (at 230 V, 50 Hz, full load)	0.15 A
Leakage current (at 230 V, 50 Hz, full load)	< 450 μ A
Mains frequency	50 / 60 Hz
Output power range	13.5 – 270 W
THD (at 230 V, 50 Hz, full load)	< 20 %
Output current tolerance [®]	\pm 7.5 %
Output LF current ripple (< 120 Hz) at full load	\pm 30 %
Starting time (at 230 V, 50 Hz, full load)	\leq 0.5 s
Turn off time (at 230 V, 50 Hz, full load)	\leq 0.5 s
Hold on time at power failure (output)	0 s
Ambient temperature ta	-20 ... +50 °C
Ambient temperature ta (at life-time 50,000 h)	40 °C
Storage temperature ts	-40 ... +80 °C
Mains burst capability	1 kV
Mains surge capability (between L – N)	1 kV
Mains surge capability (between L/N – PE)	2 kV
Surge voltage at output side (against PE)	3 kV
Life-time	up to 50,000 h
Guarantee (conditions at www.tridonic.com)	3 years
Dimensions L x W x H	230 x 30 x 21 mm
Hole spacing D	218 mm

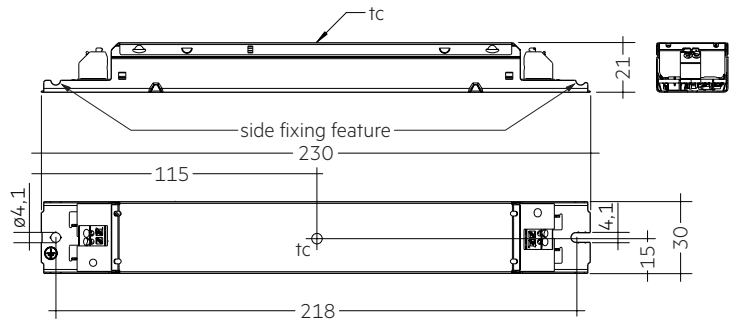

Ordering data

Type	Article number	Packaging, carton	Packaging, low volume	Packaging, high volume	Weight per pc.
LC 27/500/54 fixCC Ip SNC2	23000313	50 pc(s).	1,050 pc(s).	3,150 pc(s).	0.121 kg

Specific technical data

Type	Output current [®]	Max. input power	Typ. power consumption (at 230 V, 50 Hz, full load)	λ at full load [®]	Efficiency at full load [®]	λ at min. load [®]	Efficiency at min. load [®]	Min. forward voltage [®]	Max. forward voltage [®]	Max. output voltage (U-OUT)	Max. peak output current at full load [®]	Max. casing temperature tc
LC 27/500/54 fixCC Ip SNC2	500 mA	31 W	29.7 W	0.95	89 %	0.9C	86 %	27 V	54 V	60 V	650 mA	70 °C

[®] Test result at 230 V, 50 Hz.

[®] The trend between min. and full load is linear.

[®] Output current is mean value.

1. Standards

EN 55015
 EN 61000-3-2
 EN 61000-3-3
 EN 61347-1
 EN 61347-2-13
 EN 61547
 EN 62384

2. Thermal details and life-time

2.1 Expected life-time

Expected life-time				
Type	t_a	40 °C	50 °C	60 °C
LC 27/500/54 fixCC Ip SNC2	t_c	60 °C	70 °C	x
	Life-time	50,000 h	30,000 h	x

The LED Driver is designed for a life-time stated above under reference conditions and with a failure probability of less than 10 %.

3. Installation / wiring

3.1 Circuit diagram

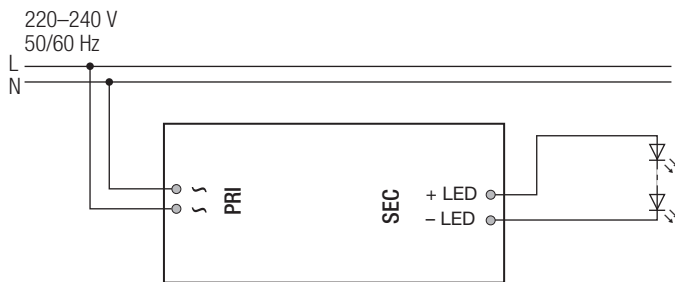

3.2 Wiring type and cross section

The wiring can be stranded wires with ferrules or rigid wires with a cross section of 0.5 – 1.5 mm². Strip 8.5 – 9.5 mm of insulation from the cables to ensure perfect operation of the push-wire terminals (WAGO 250).

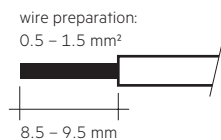

3.3 Release of the wiring

Press down the “push button” and remove the cable from front.

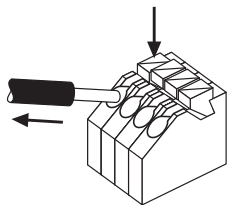

3.4 Wiring guidelines

- All connections must be kept as short as possible to ensure good EMI behaviour.
- Mains leads should be kept apart from LED Driver and other leads (ideally 5 – 10 cm distance)
- Max. length of output wires is 2 m.
- Incorrect wiring can damage LED modules.
- To avoid the damage of the Driver, the wiring must be protected against short circuits to earth (sharp edged metal parts, metal cable clips, louver, etc.).

3.5 Earth connection

The earth connection is conducted as protection earth (PE). The LED Driver can be earthed via metal housing. If the LED Driver will be earthed, protection earth (PE) has to be used. There is no earth connection required for the functionality of the LED Driver. Earth connection is recommended to improve following behaviour.

- Electromagnetic interferences (EMI)
- Transmission of mains transients to the LED output

In general it is recommended to earth the LED Driver if the LED module is mounted on earthed luminaire parts respectively heat sinks and thereby representing a high capacity against earth.

For Class I application, protection earth need to connected with the metal housing (bottom part).

For Class II application, protection earth is no need to be connected, below 2 scenarios should be considered:

- If the LED Driver housing is screw on a metal part inside the luminaires, both LED Driver and LED module must be insulated.
- If the LED Driver housing is screw on a plastic part inside the luminaires, the LED module need to be insulated.

3.6 Replace LED module

1. Mains off
2. Remove LED module
3. Wait for 30 seconds
4. Connect LED module again

Hot plug-in or output switching of LEDs is not permitted and may cause a very high current to the LEDs.

3.7 Mounting of device

Max. torque for fixing: 0.5 Nm/M4

4. Electrical values

4.1 Efficiency vs load

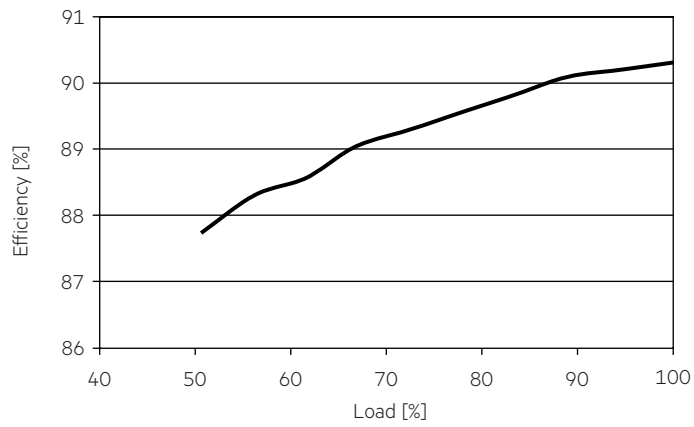

4.4 Input current vs load

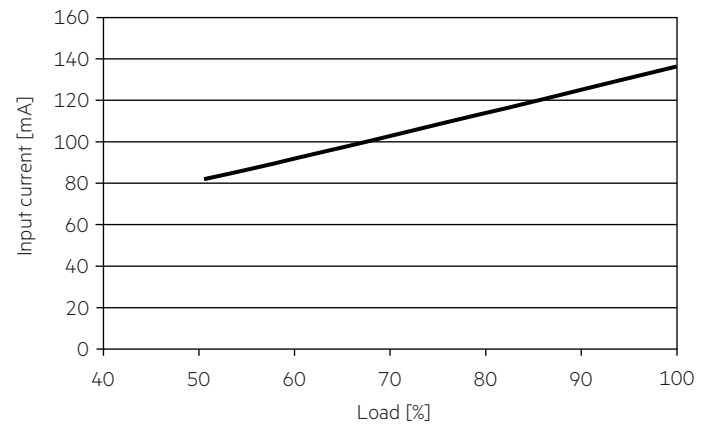

4.2 Power factor vs load

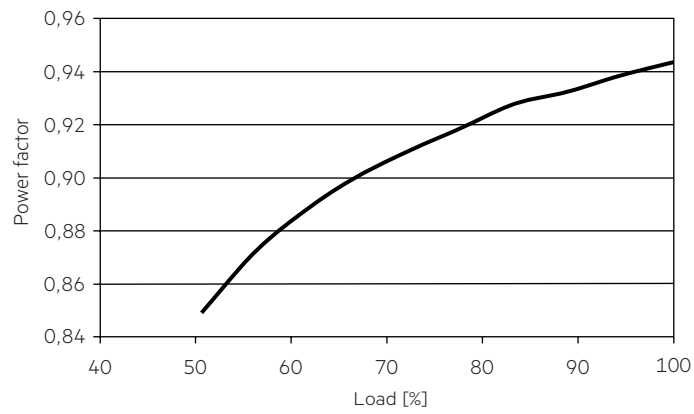

4.5 THD vs load (without harmonic < 5 mA or 0.6 % of the input current)

THD without harmonic < 5 mA (0.6 %) of the input current:

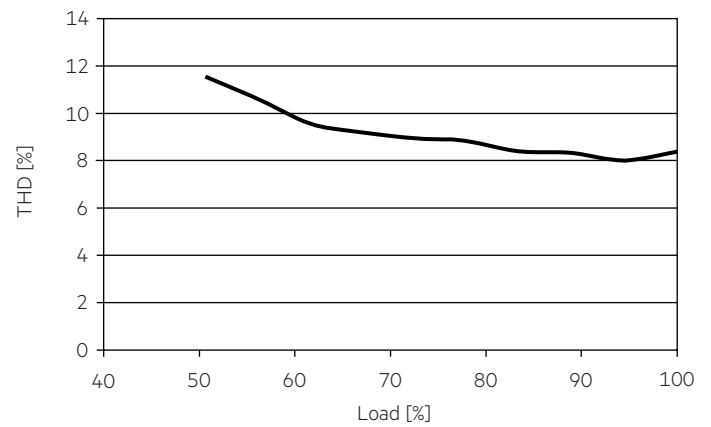

4.3 Input power vs load

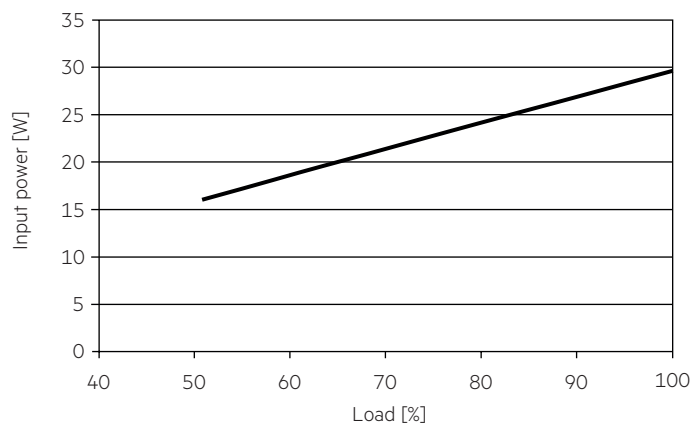

4.6 Maximum loading of automatic circuit breakers

Automatic circuit breaker type	C10	C13	C16	C20	B10	B13	B16	B20	Inrush current
Installation Ø	1.5 mm ²	1.5 mm ²	1.5 mm ²	2.5 mm ²	1.5 mm ²	1.5 mm ²	1.5 mm ²	2.5 mm ²	I _{max} Time
LC 27/500/54 fixCC Ip SNC2	45	60	75	90	36	48	60	72	10 A 100 µs

4.7 Harmonic distortion in the mains supply (at 230 V / 50 Hz and full load) in %

	THD	3.	5.	7.	9.	11.
LC 27/500/54 fixCC Ip SNC2	< 15	< 10	< 7	< 5	< 5	< 3

Acc. to 6100-3-2. Harmonics < 5 mA or < 0.6 % (whatever is greater) of the input current are not considered for calculation of THD.

5. Functions

5.1 Short-circuit behaviour

In case of a short circuit on the output side (LED) the LED Driver switches into hic-cup mode. After elimination of the short-circuit fault the LED Driver will recover automatically.

5.2 No-load operation

The LED Driver works in burst working mode to provide a constant output voltage regulation which allows the application to be able to work safely when LED string opens due to a failure.

5.3 Overload protection

If the maximum load is exceeded by a defined internal limit, the LED Driver will protect itself and LED may flicker. After elimination of the overload, the nominal operation is restored automatically.

6. Miscellaneous

6.1 Insulation and electric strength testing of luminaires

Electronic devices can be damaged by high voltage. This has to be considered during the routine testing of the luminaires in production.

According to IEC 60598-1 Annex Q (informative only!) or ENEC 303-Annex A, each luminaire should be submitted to an insulation test with 500 V_{DC} for 1 second. This test voltage should be connected between the interconnected phase and neutral terminals and the earth terminal.

The insulation resistance must be at least 2 MΩ.

As an alternative, IEC 60598-1 Annex Q describes a test of the electrical strength with 1500 V_{AC} (or 1.414 x 1500 V_{DC}). To avoid damage to the electronic devices this test must not be conducted.

6.2 Conditions of use and storage

Humidity: 5 % up to max. 85 %, not condensed (max. 56 days/year at 85 %)

Storage temperature: -40 °C up to max. +80 °C

The devices have to be within the specified temperature range (ta) before they can be operated.

6.3 Additional information

Additional technical information at www.tridonic.com → Technical Data

Life-time declarations are informative and represent no warranty claim. No warranty if device was opened.